

# CITATION MULTIBEAM 700



## OWNER'S MANUAL

**harman/kardon**  
by HARMAN

# / IMPORTANT SAFETY INSTRUCTIONS

## **Verify Line Voltage Before Use**

The CITATION MULTIBEAM 700 (soundbar) has been designed for use with 100-240 volt, 50/60 Hz AC current. Connection to a line voltage other than that for which your product is intended can create a safety and fire hazard and may damage the unit. If you have any questions about the voltage requirements for your specific model or about the line voltage in your area, contact your selling dealer before plugging the unit in to a wall outlet.

## **Do Not Use Extension Cords**

To avoid safety hazards, use only the power cord supplied with your unit. We do not recommend that extension cords be used with this product. As with all electrical devices, do not run power cords under rugs or carpets, or place heavy objects on them. Damaged power cords should be replaced immediately by an authorized service center with a cord that meets factory specifications.

## **Handle the AC Power Cord Gently**

When disconnecting the power cord from an AC outlet, always pull the plug; never pull the cord.

If you do not intend to use your speaker for any considerable length of time, disconnect the plug from the AC outlet.

## **Do Not Open the Cabinet**

There are no user-serviceable components inside this product. Opening the cabinet may present a shock hazard, and any modification to the product will void your warranty. If water accidentally falls inside the unit, disconnect it from the AC power source immediately, and consult an authorized service center.

# / TABLE OF CONTENTS

|  |    |
|--|----|
| IMPORTANT SAFETY INSTRUCTIONS.....                 | 2  |
| INTRODUCTION.....                                  | 4  |
| WHAT'S IN THE BOX.....                             | 5  |
| PRODUCT OVERVIEW.....                              | 6  |
| INSTALLATION.....                                  | 11 |
| CONNECTING TO TV.....                              | 14 |
| CONNECTING TO OTHER DEVICES.....                   | 17 |
| POWER ON.....                                      | 18 |
| CONNECTING TO INTERNET.....                        | 19 |
| SETTING UP MULTIBEAM SURROUND SOUND.....           | 20 |
| SETTING UP OTHER CITATION SPEAKERS (OPTIONAL)..... | 21 |
| USING YOUR CITATION MULTIBEAM 700.....             | 24 |
| SOUND SETTINGS.....                                | 31 |
| SETTINGS.....                                      | 33 |
| SPECIFICATIONS.....                                | 35 |
| TROUBLESHOOTING.....                               | 36 |
| TRADEMARKS.....                                    | 38 |

# / INTRODUCTION

This manual includes information of the CITATION MULTIBEAM 700 (soundbar). We encourage you to take a few minutes to read this manual, which describes the products and includes step-by-step instructions to help you set up and get started. Read and understand all the safety instructions before using your product.

**This product may have an important software update available. Please follow the instructions to connect the product to Wi-Fi to ensure that your product has the most recent software updates.**

Design and specifications are subject to change without notice.

If you have any questions about these products, their installation or their operation, please contact your Harman Kardon retailer or customer service, or visit us at [www.harmankardon.com](http://www.harmankardon.com)

# WHAT'S IN THE BOX

Carefully unpack the box and check if the following parts are included. If any part is damaged, do not use it, contact your Harman Kardon retailer or customer service.

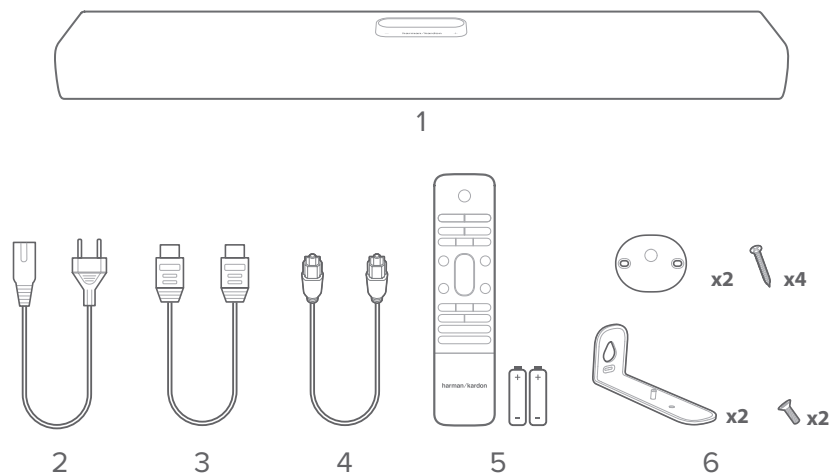

1. Main unit
2. Power cord\*
3. HDMI cable
4. Optical cable
5. Remote control (with 2 AAA batteries)
6. Wall-mounting kit

\*Power cord quantity and plug type vary by regions.

Inserting batteries before using the remote control (AAA batteries x 2)

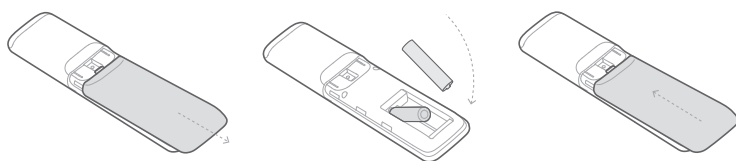

Slide the battery cover in the direction of the arrow until it is completely removed. Insert 2 AAA batteries (1.5V) oriented so that their polarity is correct. Slide the battery cover back into position.





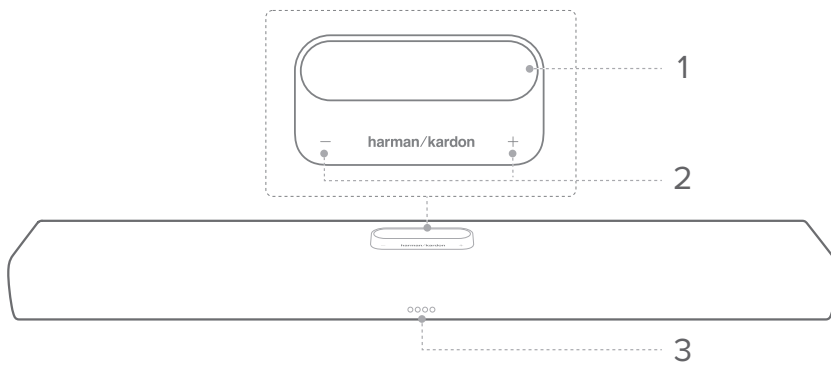



# PRODUCT OVERVIEW

## Front Panel & Top Panel



### 1. Touch screen





- Swipe up / down to switch between the main screens.
- Tap an icon to select.
- Tap ← to return to the previous screen, tap → to go to the next screen.

|   |   |
|---|---|
|  | Wi-Fi signal indicator.   |
|  | Press to mute or unmute the microphone.   |
|  | Push to talk to Google Assistant.   |
|  | Press to select a source (Bluetooth / AUX / Optical / HDMI ARC).  |
|  | Press to customize the audio settings.  |
|  | Press to customize the general settings.  |
|  | Press to set up multi-channel surround sound system with your CITATION SUB (S), CITATION SURROUND or CITATION TOWER. (Optional) |
|  | Press to check the system information of this product.  |

## 2. - / + (Volume)

- Press to decrease or increase the volume.
- Press both simultaneously to mute the soundbar audio.

## 3. LED indicators (Google)

|   |                                   |                           |
|---|-----------------------------------|---------------------------|
|    | White (Breathing slowly)          | Listening                 |
|    | White (Breathing fast)            | Responding                |
|   | Amber (Constant)                  | Microphone muted          |
|  | White (Breathing for three times) | Power on / system startup |

## Back Panel

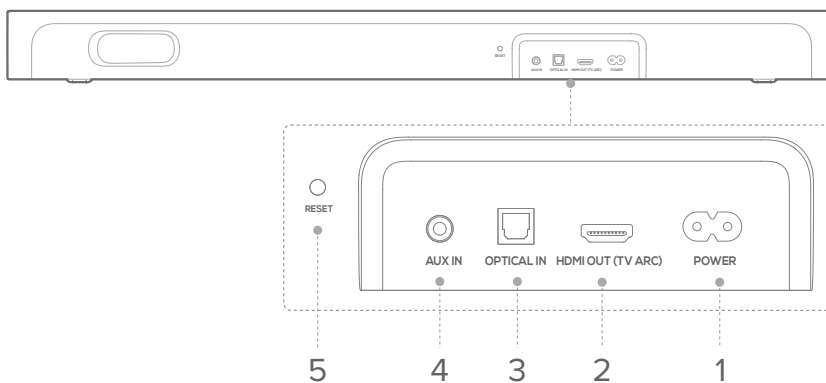

### 1. POWER

- Connect to the power supply.

### 2. HDMI ARC (TV OUT)

- Connect to the HDMI (ARC) input on your TV.

### 3. OPTICAL IN

- Connect to an optical audio output on your TV or a digital device.

#### 4. AUX IN

- Connect to an audio device (3.5mm jack).

#### 5. RESET

- Press and hold for 5 seconds to restore the factory settings.



## Remote Control

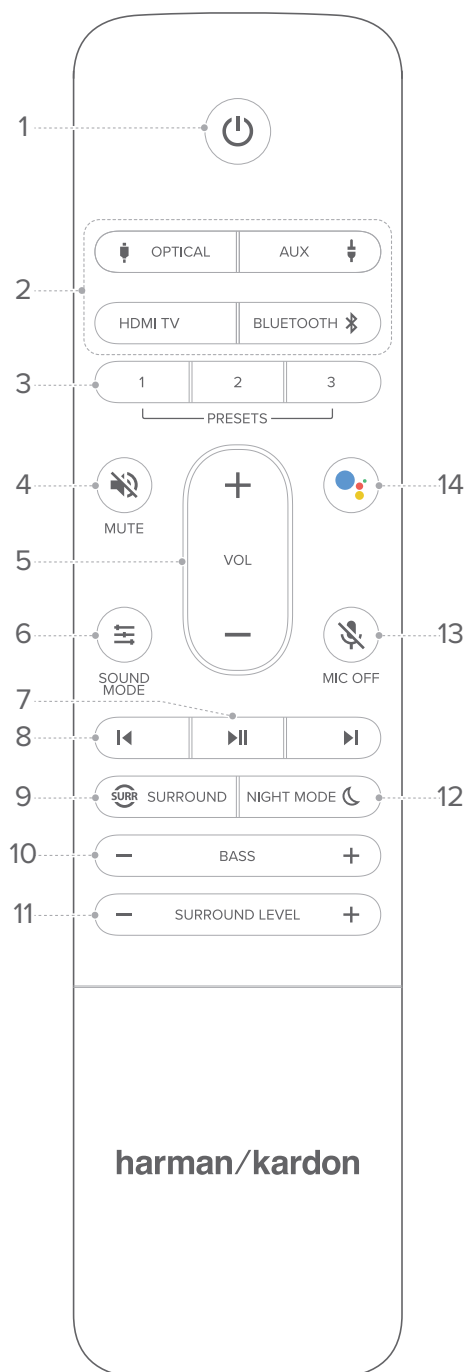

### 1. ⏻ (Power)

- Power on or switch to standby.

### 2. Source selector

- Select an input source for the soundbar: **OPTICAL / AUX / HDMI TV / Bluetooth**.
- Press and hold  to pair with a new device.

### 3. 1/2/3 PRESETS

- Select pre-recorded voice commands for source selection.

### 4. MUTE

- Mute or unmute the soundbar audio.

### 5. VOL + / -

- Increase or decrease the volume level.

### 6. SOUND MODE

- Select preset sound modes to suit your music or video: Music / Movie / News / Standard.

### 7.

- Play or pause Chromecast, AirPlay or Bluetooth playback.

### 8.

- Skip to the previous or next track for Chromecast, AirPlay or Bluetooth playback.

## 9. SURROUND

- Decrease or increase the MultiBeam™ surround sound effect (for a standalone soundbar); or turn surround upmixing on or off (after you connect the optional satellite speakers CITATION SURROUND or CITATION TOWER)

## 10. BASS - / +

- Decrease or increase the bass level of the soundbar (after you connect the optional subwoofer CITATION SUB (S)).

## 11. SURROUND LEVEL - / +

- Decrease or increase surround sound effect (after you connect the optional satellite speakers CITATION SURROUND or/ and CITATION TOWER).

## 12. NIGHT MODE

- Turn the night mode (Dynamic Range Control) on or off for Dolby Digital tracks.

## 13. MIC OFF

- Turn the microphone on the soundbar on or off.

## 14.

- Push to talk to Google Assistant.

# / INSTALLATION

## Placement

### NOTES:

- To avoid wireless interference, keep a minimum distance of 5 meters (16.4 feet) between other wireless devices and the soundbar.
- Make sure that there is an AC (mains) outlet nearby.

Place the soundbar on its rubber feet on a stable and level surface below your TV.

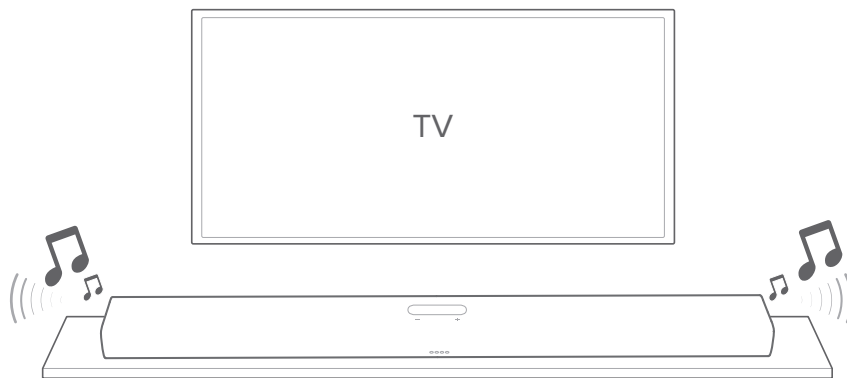

### CAUTION:

- Do not place the soundbar on its front, back or top when in use.
- Do not place any objects on top of the soundbar.

## Wall-mount

### NOTES:

- Before mounting on a wall, make sure the wall can support the weight of this product.
- For the wall mounting, avoid a location with high temperature or humidity. Install on a vertical wall only.
- Connect cables from the product to external devices before mounting on the wall.
- Before moving or installing the product, make sure to power off and unplug first. Otherwise, it may cause an electric shock.
- Do not connect the power cord of the soundbar or your TV to a wall outlet until all connections between components are complete.
- Leave a clearance of at least 5 cm (1.9 in) between the top of the soundbar and the bottom of the TV.

- 1) Use tape to stick the wall-mounted paper guide on the wall, push a pen tip through the center to mark the wall-mounted bracket location and remove the paper.

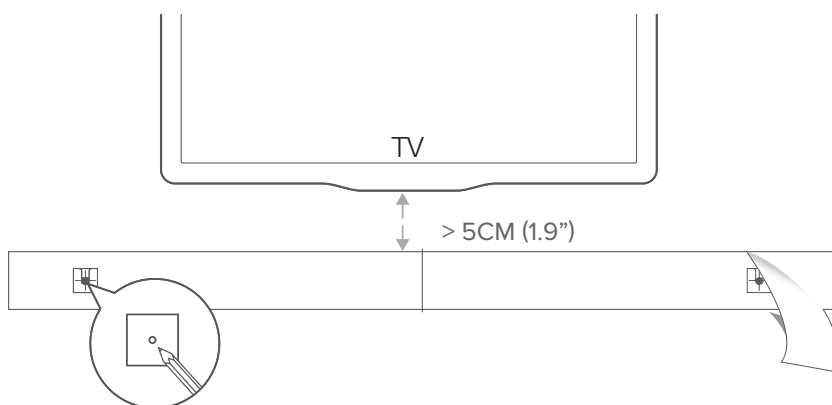

- 2) Screw the wall-mount brackets on the pen mark; screw the threaded mounting post into the back of the soundbar, then hook the soundbar on the wall.

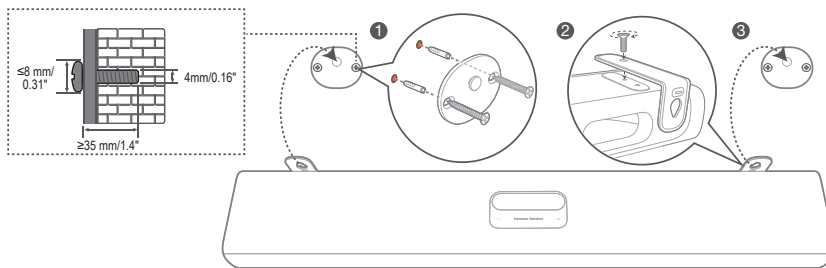

# / CONNECTING TO TV

## NOTES:

- If you want to enjoy sound only from the soundbar, make sure to set your TV audio settings to support external speakers and disable the built-in TV speakers.
- Before you make or change any connections, make sure that all devices are disconnected from the power outlet.

## HDMI (Preferred)

- 1) Connect the supplied HDMI cable from the **HDMI OUT (TV ARC)** connector on the back of the soundbar to the **HDMI IN (ARC)** connector on your TV.
- 2) Press  **HDMI ARC** on the touch screen or press the **HDMI TV** button on the remote control to select the **TV ARC** mode.

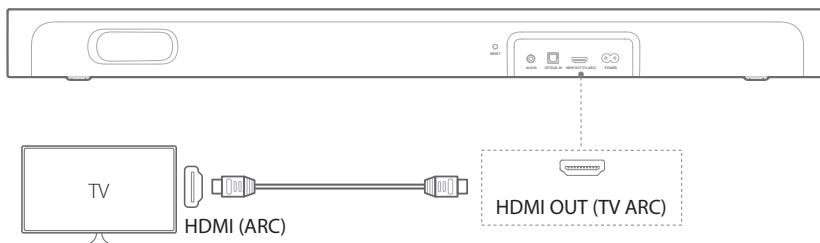



## NOTES:

- An HDMI connection supports digital audio and video with a single connector. It is the best option to connect to your soundbar.
- If your TV features an HDMI ARC connector, you can enjoy the TV audio through your soundbar by using a single HDMI cable.
- This HDMI connection is required if you intend to connect other video devices to the soundbar inputs to display on your TV.

## Optical

### NOTE:

- Make sure you have removed the protective cap from both ends of the optical cable.
- 1) Connect the **OPTICAL IN** connector on the soundbar to the **OPTICAL OUT** connector of your TV with the optical cable.
  - 2) Press  **OPTICAL IN** on the touch screen or press the  **OPTICAL** button on the remote control to select the **OPTICAL** mode.

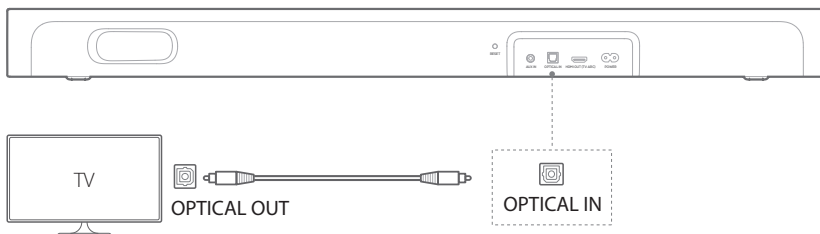



## TV Remote Control Setup

To use your TV remote control for both your TV and the soundbar, check that your TV supports HDMI-CEC. If your TV does not support HDMI-CEC, follow the steps under “TV remote control learning”.

### HDMI-CEC

If your TV supports HDMI-CEC, enable the functions as instructed in your TV user manual. You can control the volume +/-, mute/unmute, source selector and power on/standby functions on your soundbar through the TV remote control.

## TV remote control learning

- 1) On the soundbar, swipe the touch screen up/down/left/right to select  >  on the main screen.

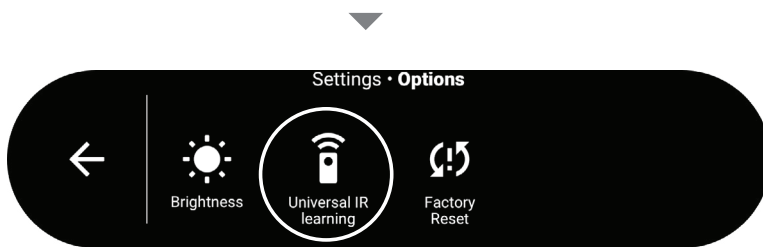
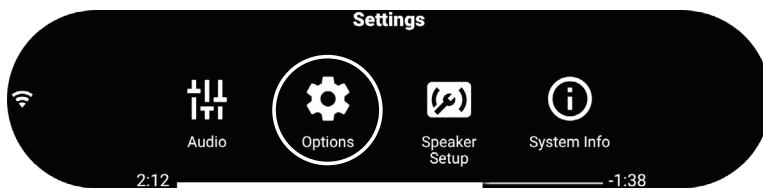

- 2) Press the  button to start the Universal IR learning on your TV remote control.

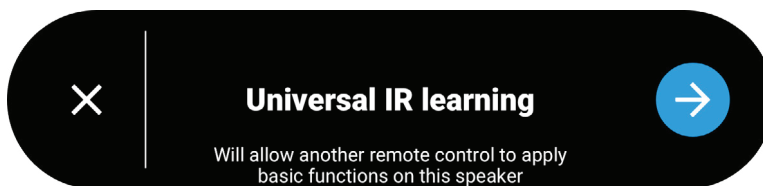

- 3) Point your TV remote control at the soundbar. Follow the screen instructions to operate the buttons on your TV remote control.

### NOTES:

- The source selector on your TV remote control can only select the source device that is connected to the soundbar through cables, like **OPTICAL / AUX / HDMI TV**.



# CONNECTING TO OTHER DEVICES

## Optical or Analog

- 1) Connect the **OPTICAL IN** or **AUX IN** connector on the soundbar to the **OPTICAL OUT** or **AUDIO OUT** jack of the source device by using the optical cable or a 3.5mm audio cable (sold separately).
- 2) Press **OPTICAL IN** or **AUX** on the touch screen or press the **OPTICAL** or **AUX** button on the remote control to select the **OPTICAL** or **AUX** mode.

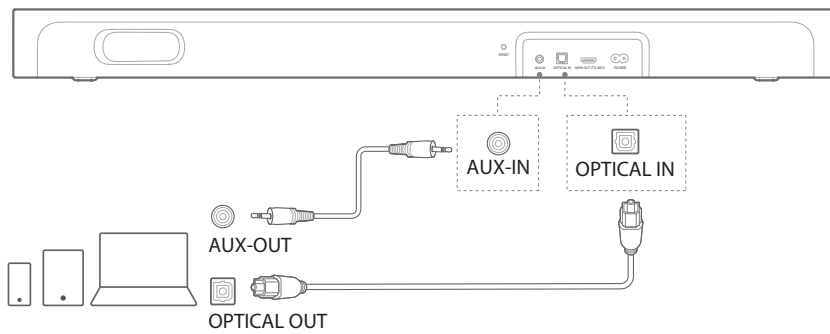

# / POWER ON

## NOTES:

- Use the provided power cord only.
- Before connecting the power cord, make sure all other connections have been completed.
- When you disconnect the power cord, always pull the plug, never the cable.
- Do not connect this product or other components to an AC outlet until all connections between components are complete.

- 1) Plug one end of the AC power cord into the **POWER** connector on the back of the soundbar.
- 2) Plug the other end of the power cord into a live AC (mains) outlet. The soundbar will automatically power on and the touch screen will turn on. Alternatively, press  on the remote control to power on or switch to standby.



- 3) Select your language as instructed on the touch screen for the first-time setting.

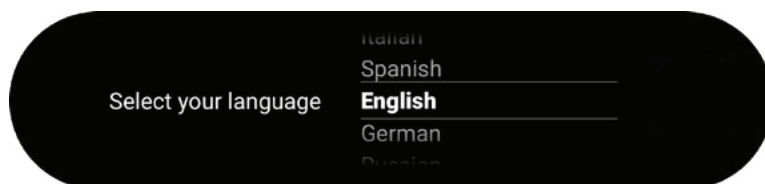

# CONNECTING TO INTERNET

With the Google Home app, connect your CITATION MULTIBEAM 700 to the Internet through Wi-Fi.

- 1) Download the Google Home app on your smartphone or tablet.
- 2) Power on your CITATION MULTIBEAM 700.
- 3) Run the Google Home app and set up your CITATION MULTIBEAM 700 as instructed in the app. Always follow the instructions in the app to complete the Internet setup.
- 4) Sign in with your Google account. If you do not have, create a new one.

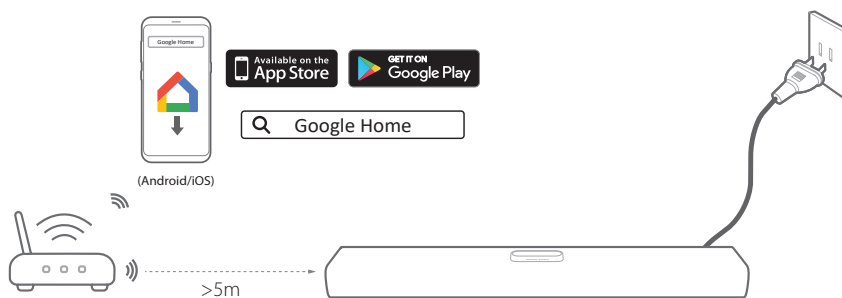



\* To avoid any interference, keep a minimum distance of 5 meters (16.4 feet) between the soundbar and your Wi-Fi router.

## CAUTION:

- If you encounter any setup issues, make sure to enable Bluetooth and location services on your smartphone or tablet.
- In the Google Home app, you can rename this product. The device name will remain during Bluetooth device discovery and Chromecast and AirPlay streaming.
- Once this product is connected to the Internet, it will receive a periodic over-the-air software update to improve performance. This update may take a few minutes to complete.

# SETTING UP MULTIBEAM SURROUND SOUND

Automatic MultiBeam Calibration (AMC) will optimize the soundbar sound settings for a better surround sound experience.

- On the soundbar, swipe the touch screen up/down/left/right to select  >  on the main screen.

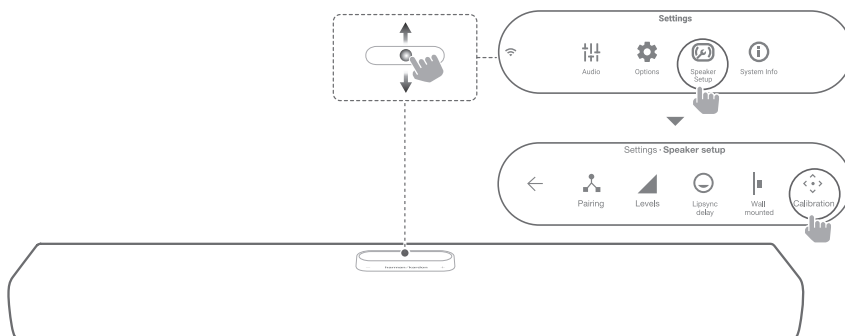

## NOTE:

- The MultiBeam surround sound effect works best with hard walls between 1.5 to 4.5 meters (5 to 15 feet) to the left and right of the MULTIBEAM 700.

# / SETTING UP OTHER CITATION SPEAKERS (Optional)

You can wirelessly pair your CITATION MULTIBEAM 700 with:

- CITATION SUB (S) (subwoofer, sold separately): to enhance the bass performance;
- CITATION SURROUND or CITATION TOWER (satellite speakers, sold separately): to set up a 5.0 channel surround sound system (with virtual surround speakers);
- CITATION SUB (S) and CITATION SURROUND/CITATION TOWER: to set up a 5.1 channel surround sound system (with virtual surround speakers);
- CITATION SUB (S), CITATION TOWER and CITATION SURROUND: to set up a 5.1 channel surround sound system.

## NOTES:

- For a successful setup, keep a maximum distance of 5 meters (16.4 feet) between the CITATION MULTIBEAM 700 and your CITATION SUB or CITATION SURROUND.
- If the soundbar is powered off, the satellite speakers or subwoofer will enter standby mode.
- If you use a device that uses the same frequency (2.4GHz or 5GHz) as the soundbar near your soundbar, interference may cause some sound interruption.
- The maximum transmission distance of the wireless signal between the soundbar and satellite speakers or subwoofer may vary depending on your operating environment.

- 1) Power on your CITATION MULTIBEAM 700, CITATION SUB, or / and CITATION SURROUND.
  - To set up CITATION TOWER as part of a surround system, select “**Video**” to enter “**Surround Mode**” the first time you power on the CITATION TOWER speakers. If necessary, restore CITATION TOWER to factory settings.

- 2) Press **“Speaker Setup”** > **“Pairing”** > **“Surround Setup”** or **“Subwoofer Setup”** on the touch screen to enter pairing mode.
  - You will hear a pairing chime once successfully connected and **“Surround setup successful”** or **“Subwoofer connected”** will be displayed on the touch screen.
  - If no speakers are found, make sure to power on every speaker and retry the setup.
- 3) To remove the setup, press **“Surround Setup”** or **“Subwoofer pairing”** again, or reset the soundbar.

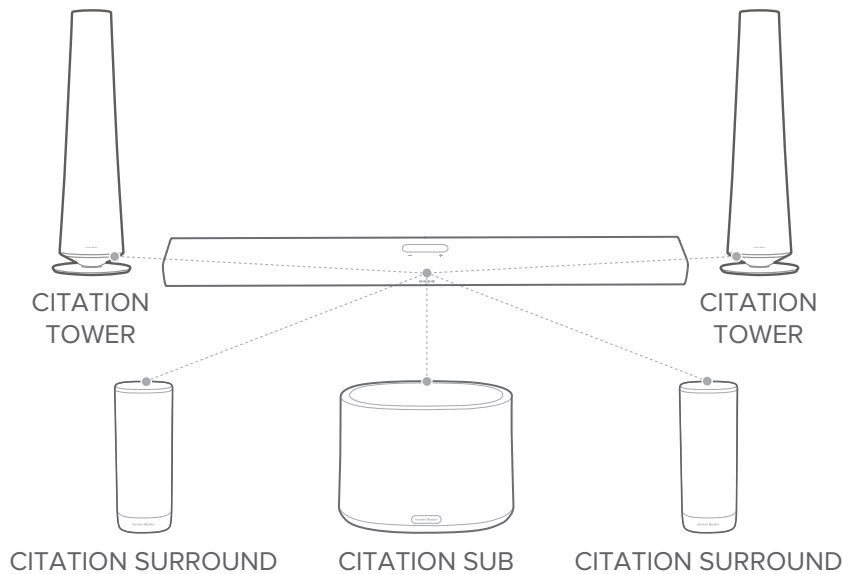

**LED Indicator (CITATION SUB / CITATION SURROUND)**

|   |  |  |
|---|--|--|
| ☉ | White (Flashing)                                   | Pairing  |
| ☉ | White (Flashing)                                   | Out of range / Lost wireless connection          |
| ○ | White (Constant for 10 seconds and then light off) | Wirelessly connected with CITATION MULTIBEAM 700 |

## Test Tone

Press **“Speaker Setup”** > **“Levels”** > **“Test tone”** to play the test tone. Each speaker location icon will blink in sequence.

## Speaker Volume and Bass

Press **“Speaker Setup”** > **“Levels”** > **“Speaker volume trim”** or **“Bass level trim”**, then swipe up / down to select speakers or adjust the volume and bass level.

# / USING YOUR CITATION MULTIBEAM 700

## Use Voice Commands

### Talk to Google Assistant

Your CITATION MULTIBEAM 700 comes with the Google Assistant built-in. You can play music, get answers, manage everyday tasks, and easily control smart devices around your home by using your voice.

Press  on the remote control or on the touch screen to activate the Google Assistant and then say your request.

When the CITATION MULTIBEAM 700 is streaming music through Chromecast, AirPlay or Bluetooth, you can say the wake word “**Ok Google**” or “**Hey Google**” first and then your request.

→ CITATION MULTIBEAM 700 will respond instantly.



### NOTE:

- With the Google Home app on your Android or iOS device, set up your Google Assistant on the soundbar.
- For the latest voice commands, please visit [assistant.google.com](https://assistant.google.com).

### Select sources through the pre-recorded voice commands

With the pre-recorded voice commands, you can switch between sources on the soundbar, including OPTICAL, AUX, HDMI TV and online audio services supported by Google Assistant.



- 1) On the soundbar, swipe the touch screen up/down/left/right to select the main screen of Voice Presets.

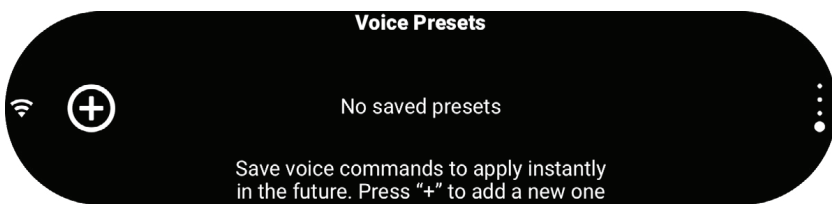

- 2) Tap + to start recording voice commands.
  - Speak out a source on the soundbar or an online audio service supported by Google Assistant.
  - To save the recording, tap ✓. To discard the recording, tap →.

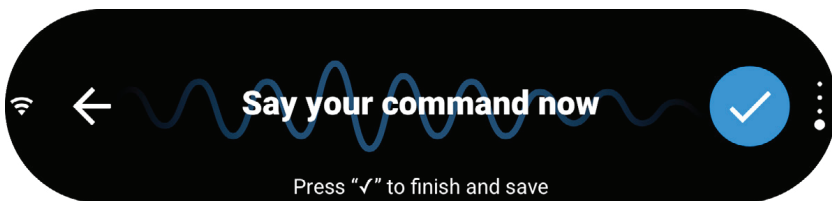

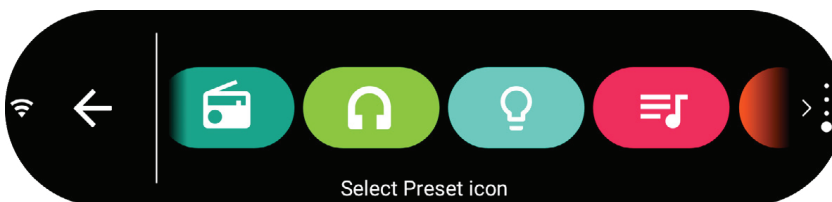

- 3) After the voice command is recorded, select an icon for the voice preset.
  - You can save up to 8 voice presets.

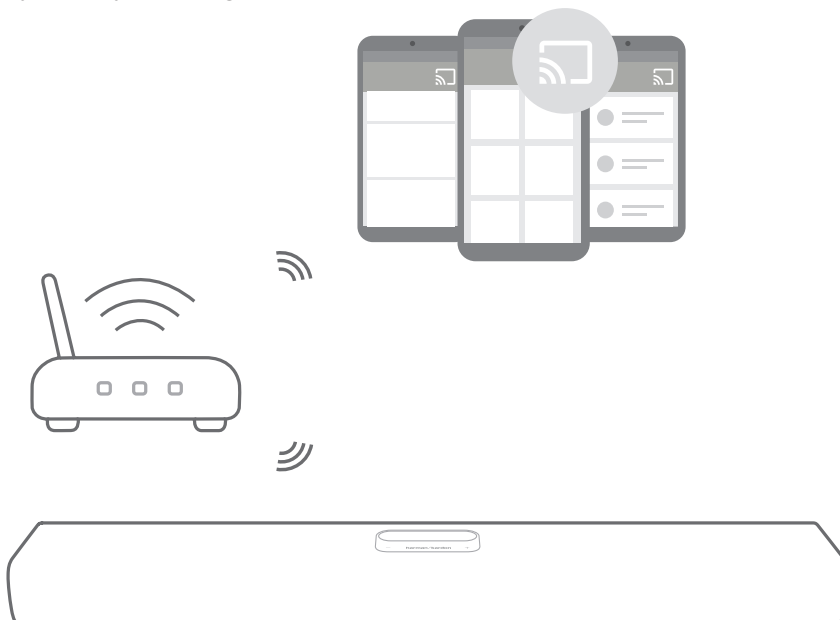

## Chromecast

With Chromecast built-in, you can stream music, tunes, podcasts, and playlists from 300+ music apps to your soundbar by simply tapping the **Cast** button .



- 1) Check that your smartphone or tablet has been connected to the same network as the soundbar.
- 2) Run the Chromecast enabled app on your smartphone or tablet.
- 3) Play music. Press the  icon and select “Citation MultiBeam 700”.
- 4) To exit from the music playback, switch to other sources.

### NOTES:

- The name of this product is assigned during the Wi-Fi setup.
- The soundbar can support audio streaming but not video streaming.

## AirPlay

With AirPlay, you can stream music on your iOS device to the soundbar.

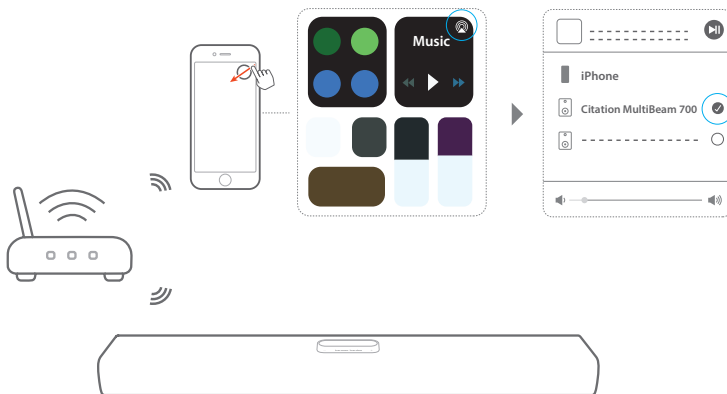

- 1) Check that your iOS device has been connected to the same network as the soundbar.
- 2) To enter the Control Center on an iOS device, swipe down from the upper right corner (iOS 12 or later) or swipe up from the bottom edge (iOS 11 or earlier). Tap  to select the connected soundbar and then, start audio streaming from an app.
- 3) To exit from the music playback, switch to other sources.

## Multi-room Playback

With the multi-room playback, you can stream music on your Android or iOS device to multiple CITATION speakers.

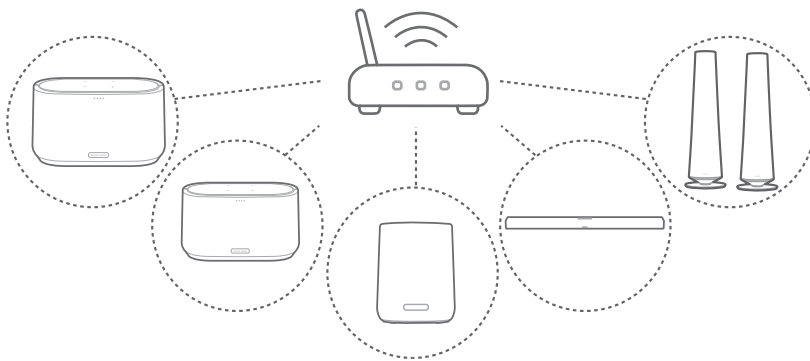

### Chromecast

- 1) Through the Google Home app, connect multiple CITATION speakers to the same network, assign them to multiple rooms, and create groups as needed.
- 2) Run the Chromecast enabled app on your smartphone or tablet.
- 3) Play music. Press the  icon and select the grouped speakers.

### NOTES:

- Refer to Google Home app for more details.
- The amount of Chromecast speakers you can stream music to depends on the bandwidth of your local wireless network. Theoretically, an unlimited amount of devices can be connected to stream the same song.

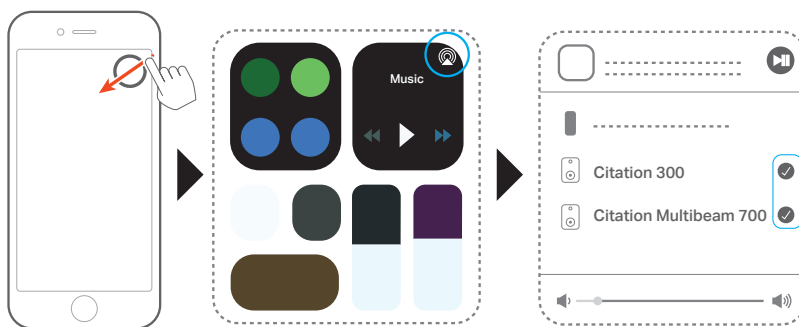

## AirPlay





- 1) On an iOS device, enter the Control Center.
- 2) Tap  to select multiple connected speakers as needed.
- 3) Start music streaming from an app.

## Bluetooth



You can use your CITATION MULTIBEAM 700 as a speaker for your Bluetooth enabled smartphone or tablet.

- 1) Press  on the remote control or press  **Bluetooth** on the touch screen to enter Bluetooth pairing mode.
  - During the 10 seconds of reconnection period, or until a successful connection, the white circle below  icon will blink.
- 2) On your smartphone or tablet, select “**Citation MultiBeam 700**” to connect. You will hear a pairing chime once connected.
  - When the music is playing, the track, title and artist of the song will scroll on the touch screen.

**NOTES:**

- If you have already connected the soundbar to Wi-Fi and changed the device name, then select the new device name.
- To exit the Bluetooth mode, choose other sources.
- To disconnect and pair another device, press and hold  until the white circle below  blinks.
- The soundbar automatically turns off after 20 minutes of inactivity.
- Bluetooth performance can be affected by the distance between this product and your Bluetooth device and the environment of operation.
- Keep a maximum distance of 10 meters (33 feet) between this product and your Bluetooth device to avoid disconnection.

**Playback Controls**

- : Start, pause or resume play.
- : Skip to previous / next track.

**NOTES:**

- During Chromecast, AirPlay or Bluetooth streaming, music playback pauses on the current connected device when you start music playback on a second connected device.



# / SOUND SETTINGS

This section helps you choose the ideal sound for your video or music.



## Volume

You have four ways to adjust the volume level while playing music.

- Press or press and hold - / + button on the top panel or **VOL + / -** on the remote control.
- Softly drag the volume bar.
- Adjust the volume via the Google Home app on your smartphone or tablet.
- Ask Google Assistant to adjust the volume by your voice.

To mute the soundbar sound, press  MUTE on the remote control. To restore the sound, press  MUTE again or adjust the volume.

## Sound Mode

Press  **SOUND MODE** on the remote control or press  **Audio** on the touch screen, then select predefined sound modes to suit your music or video.

- **Virtual Surround:** Increases the MultiBeam surround sound effect, or turns on or off surround upmixing (after you connect CITATION SURROUND or CITATION TOWER)
- **Night Mode:** Decreases the volume of loud sounds. (Available only for Dolby Digital soundtracks)
- **Music Mode:** Creates stereo sound.
- **Movie Mode:** Creates a surround listening experience.
- **News Mode:** Makes human voice more clear and reduces bass.
- **Standard:** Resumes the original sound.

## Synchronize Video and Audio

If the audio and video are not synchronized, swipe up/down the touch screen to select “**Speaker Setup**” > “**Lipsync delay**” and delay the audio to match the video.



# / SETTINGS

## Display Brightness

Press **Options** > **Brightness**, then softly drag the value bar to adjust the brightness of the touch screen.

## Software Upgrade

The software of your CITATION MULTIBEAM 700 will be automatically upgraded to the latest version when it is connected to the Internet via a Wi-Fi network or Ethernet connection.

## Restore Factory Settings

To restore the default settings programmed at the factory:

- Press “**Options**” > “**Factory Reset**” on the touch screen; or
- Press and hold the **RESET** button on the back of your CITATION MULTIBEAM 700 for 5 seconds.

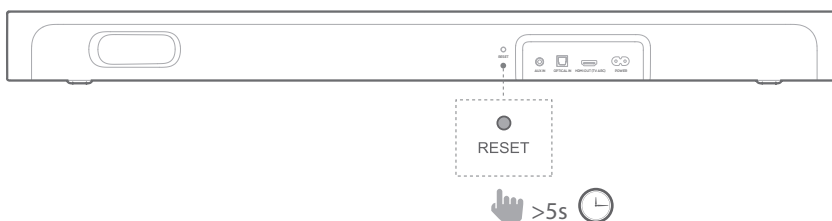

When the factory settings restore is complete, the CITATION MULTIBEAM 700 will automatically power off and restart. Any stored information or settings will be erased.

## System Information

Press “**System info**” on the touch screen to view the system information:

- **Country:** Country and language.
- **Network:** Network SSID, signal strength and Wi-Fi address.
- **About:** Model and name.
- **Software version:** Software version and date of last update.

## Cleaning and Maintenance

To keep the exterior surface of your CITATION MULTIBEAM 700 clean, unplug the AC power cord from the speaker first, wipe the exterior surfaces gently with a clean, soft cloth.

### CAUTION:

- Do not use alcohol, benzene, or thinner to clean the fabric surface.

# / SPECIFICATIONS

- Power supply: 100 - 240 V ~ 50 / 60 Hz
- Output power: 210 W RMS
- Bluetooth version: 4.2
- Bluetooth transmitter frequency range: 2402 - 2480MHz
- Bluetooth transmitter power: <10 dBm (EIRP)
- Bluetooth transmitter modulation: GFSK,  $\pi/4$  DQPSK, 8DPSK
- Wireless network: 802.11b/g/n/ac (2.4GHz/5GHz)
- 2.4G Wi-Fi transmitter frequency range: 2412 - 2472 MHz (2.4GHz ISM Band, USA 11 Channels, Europe and others 13 Channels)
- 2.4G Wi-Fi transmitter power: <20 dBm (EIRP)
- 2.4G Wi-Fi modulation: DBPSK, DQPSK, CCK, QPSK, BPSK, 16QAM, 64QAM
- 5G WISA transmitter power: <14 dBm (EIRP)
- 5G WISA modulation: OFDM, BPSK, QPSK, 16QAM
- 5G WISA transmitter frequency range: 5.15 - 5.35 GHz, 5.470 - 5.725GHz, 5.725 - 5.825GHz
- 5G Wi-Fi transmitter power: <23 dBm (EIRP)
- 5G Wi-Fi modulation: QPSK, BPSK, 16QAM, 64QAM, 256QAM
- 5G Wi-Fi transmitter frequency range: 5.15 - 5.35GHz, 5.470 - 5.725GHz, 5.725 - 5.825GHz
- Operating temperature: 0 - 45°C

# / TROUBLESHOOTING

Never try to repair the product yourself. If you have any problems using this product, check the following points before you request service.

## Sound

### No sound from the soundbar.

- Make sure that the soundbar is not muted.
- Make sure to select the correct audio input source.

### No sound from CITATION SUB (S), CITATION TOWER or CITATION SURROUND.

- Check if the subwoofer or the satellite speakers LED is in solid white color. Blinking LED means a disconnection. Manually pair them with the soundbar.
- Play the test tone (See “Test Tone” in the “SETTING UP OTHER CITATION SPEAKERS (OPTIONAL)” chapter).

### Distorted sound or echo.

- If you play audio from the TV through the soundbar, make sure the TV is muted or the built-in TV speaker is disabled.

### Audio and video are not synchronized.

- Press **AUDIO SYNC +/-** to synchronize.

## Bluetooth

### A device cannot connect with the soundbar.

- Check if you enable the Bluetooth function of the device.
- The soundbar is already connected to another Bluetooth device. Press  on the remote control to disconnect and pair with a new device.

**Poor audio quality from a connected Bluetooth device.**

- The Bluetooth reception is poor. Move the device closer to the soundbar, or remove any obstacle between the device and the soundbar.

**Wi-Fi****Failed to connect to Wi-Fi.**

- Make sure that Wi-Fi is turned on.
- Make sure that you have selected the right network and entered the correct password.
- Make sure that your router or modem is turned on and within the range.
- Make sure that your CITATION speaker is connected to the same wireless LAN as your smartphone or tablet.

**The Google Home app cannot find the device.**

- Make sure that your CITATION speaker is powered on.
- Make sure that your network is working properly.
- Make sure that your router or modem is powered on and within the range.

**No response to the voice command.**

- Depending on the location of your CITATION speaker, the ambient conditions may prevent the CITATION speaker from detecting the voice command “**Ok Google**”. Avoid placing the CITATION speaker in a noisy place or a place that is exposed to strong winds or echoes (sound reflections).
- Make sure that the built-in microphone is not muted.
- If you use the HDMI / Optical / Aux input or 5.1 multi-channel surround sound system, press  on the remote control or on the touch screen to activate the Google Voice Assistant.

# / TRADEMARKS



The Bluetooth® word mark and logos are registered trademarks owned by the Bluetooth SIG, Inc. and any use of such marks by HARMAN International Industries, Incorporated is under license. Other trademarks and trade names are those of their respective owners.



The Wi-Fi CERTIFIED Logo is a certification mark of the Wi-Fi Alliance.



Manufactured under license from Dolby Laboratories. Dolby, Dolby Audio, Pro Logic and the double-D symbol are trademarks of Dolby Laboratories.



The terms HDMI, HDMI High-Definition Multimedia Interface, and the HDMI logo are trademarks or registered trademarks of HDMI Licensing Administrator, Inc.



Google, Google Play, Chromecast, and other related marks are trademarks of Google LLC. Chromecast built-in may require subscription(s). The Google Assistant requires an internet connection and is not available in certain countries and languages. Availability and react of certain features and services are device, service, and network-dependent and may not be available in all areas. Controlling certain devices in your home requires compatible smart devices. Subscriptions for services and applications may be required and additional terms, conditions and/or charges may apply.



Apple®, AirPlay®, iPad®, iPad Air®, iPad Pro®, and iPhone® are trademarks of Apple Inc., registered in the U.S. and other countries.

Use of the Works with Apple badge means that an accessory has been designed to work specifically with the technology identified in the badge and has been certified by the developer to meet Apple performance standards.

To control this AirPlay 2-enabled speaker, iOS 11.4 or later is required.

**harman / kardon**<sup>®</sup>  
by HARMAN